

# PQ05RR12/13

1A Output, Low Power-Loss Voltage Regulators(Built-in Reset Signal Generating Function)

## ■ Features

- Compact resin full-mold package
- Low power-loss (Dropout voltage : MAX. 0.5V)
- The regulators are provided with reset signal generating function to prevent errors of microcomputer when input voltage is applied and output voltage drops.
- High-precision output type  
(Output Voltage precision :  $\pm 2.5\%$ ) (PQ05RR13)

## ■ Applications

- Series power supply for equipment such as TVs, VCRs and electronic music instruments

## ■ Outline Dimensions

(Unit : mm)

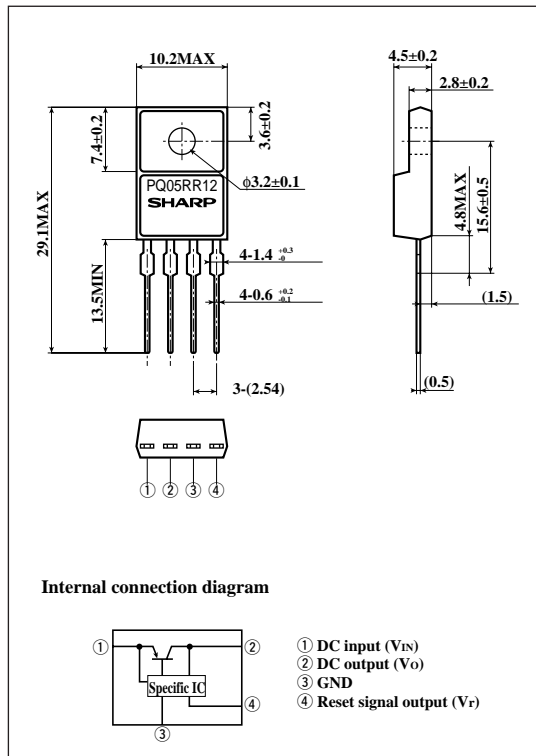

## ■ Absolute Maximum Ratings

( $T_a=25^{\circ}\text{C}$ )

Parameter	Symbol	Rating	Unit
*1 Input voltage	$V_{IN}$	24	V
*1 Reset output voltage	$V_r$	24	V
Output current	$I_O$	1	A
Reset output current	$I_r$	10	mA
Power dissipation (No heat sink)	$P_{D1}$	1.5	W
*2 Power dissipation (With infinite heat sink)	$P_{D2}$	15	W
Junction temperature	$T_j$	150	$^{\circ}\text{C}$
Operating temperature	$T_{opr}$	-20 to +80	$^{\circ}\text{C}$
Storage temperature	$T_{stg}$	-40 to +150	$^{\circ}\text{C}$
*3 Soldering temperature	$T_{sol}$	260	$^{\circ}\text{C}$

\*1 All are open except GND and applicable terminals.

\*2 Overheat protection may operate at  $125 \leq T_j \leq 150^{\circ}\text{C}$ .

\*3 For 10s

SHARP

" In the absence of confirmation by device specification sheets, SHARP takes no responsibility for any defects that may occur in equipment using any SHARP devices shown in catalogs, data books, etc. Contact SHARP in order to obtain the latest version of the device specification sheets before using any SHARP's device. "

■ Electrical Characteristics

(Unless otherwise specified, condition shall be  $V_{IN}=7V, I_o=0.5A, T_a=25^{\circ}C$ )

Parameter	Symbol	Conditions	MIN.	TYP.	MAX.	Unit	
Output voltage	$V_o$	-	PQ05RR12	4.75	5.0	5.25	V
			PQ05RR13	4.88	5.0	5.12	
Load regulation	$R_{egL}$	$I_o=5mA$ to 1.0A	-	0.1	2.0	%	
Line regulation	$R_{egI}$	$V_{IN}=6$ to 12V	-	0.5	2.5	%	
Temperature coefficient of output voltage	$T_cV_o$	$T_J=0$ to 125°C	-	$\pm 0.02$	-	%/°C	
Ripple rejection	RR	Refer to Fig. 2	45	55	-	dB	
Dropout voltage	$V_{i-o}$	<sup>*4</sup>	-	-	0.5	V	
Low reset output voltage	$V_{rl}$	$I_o=5mA, I_r=5mA$	-	-	0.8	V	
Reset threshold voltage	$V_{rt}$	$I_o=5mA, ^{*5}$	3.55	3.75	3.95	V	
Reset output leak current	$I_{rlk}$	$I_o=5mA, V_r=24V$	-	-	30	$\mu A$	
Quiescent current	$I_q$	$I_o=0$	-	-	10	mA	

<sup>\*4</sup> Input voltage shall be the value when output voltage is 95% in comparison with the initial value.

<sup>\*5</sup> Output voltage shall be the value when input voltage lowers and  $V_r$  becomes low.

Fig.1 Test Circuit

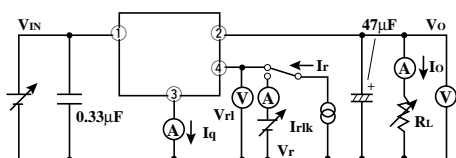
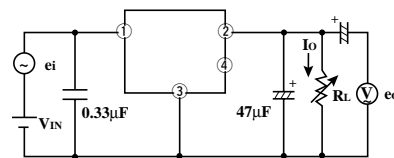
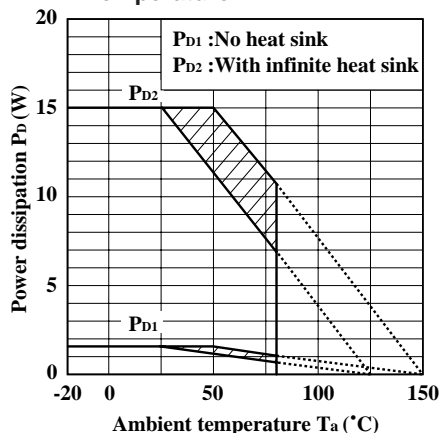

Fig.2 Test Circuit of Ripple Rejection



$f=120Hz$  (sine wave)  
 $e_i=0.5V_{rms}$   
 $RR=20 \log (e_i/e_o)$

Fig.3 Power Dissipation vs. Ambient Temperature



Note) Oblique line portion: Overheat protection may operate in this area.

Fig.4 Overcurrent Protection Characteristics (Typical value)

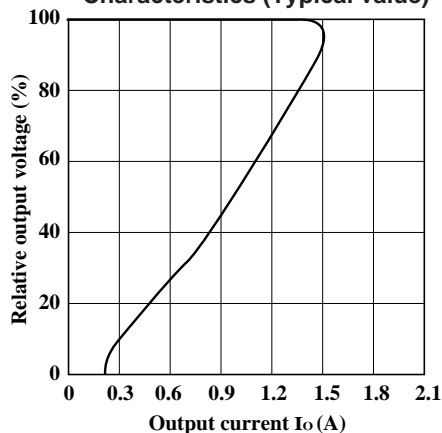

Fig.5 Output Voltage Deviation vs. Junction Temperature

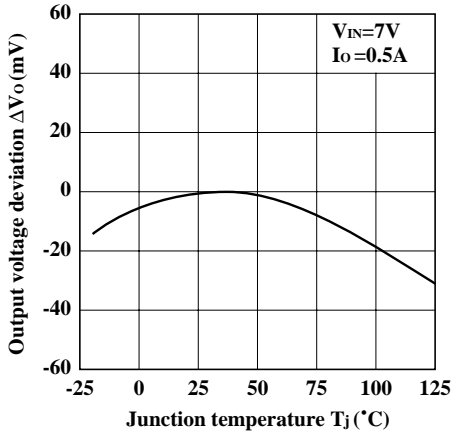

Fig.6 Output Voltage vs. Input Voltage

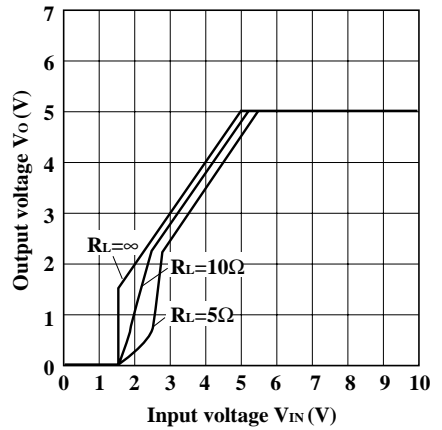

Fig.7 Circuit Operating Current vs. Input Voltage

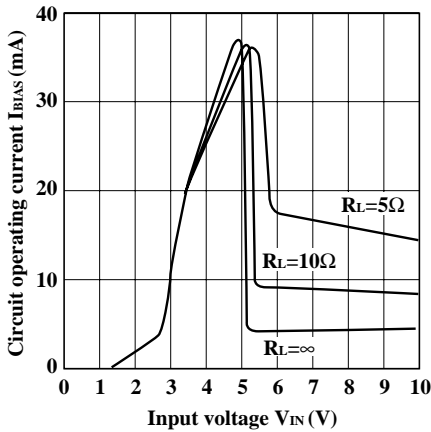

Fig.8 Quiescent Current vs. Junction Temperature

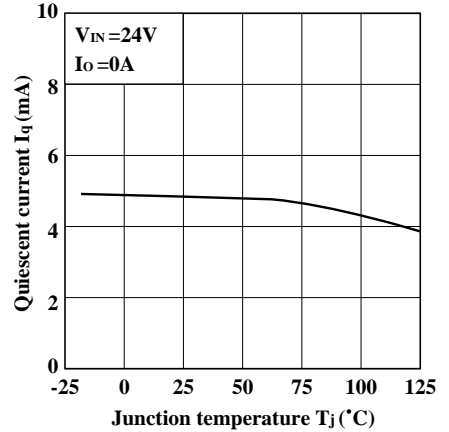

Fig.9 Ripple Rejection vs. Input Ripple Frequency

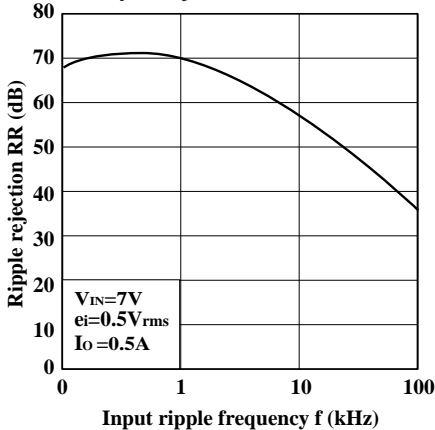

Fig.10 Ripple Rejection vs. Output Current

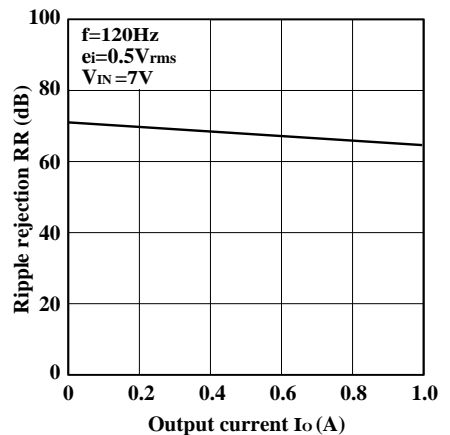

Fig.11 Output Peak Current vs. Junction Temperature

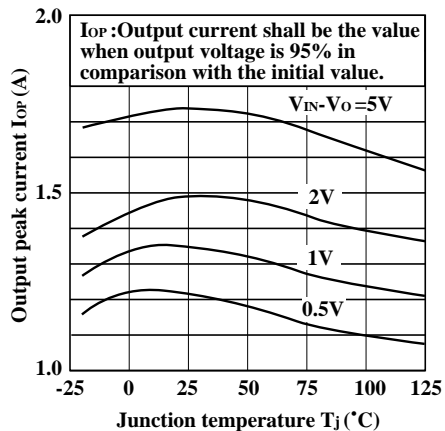
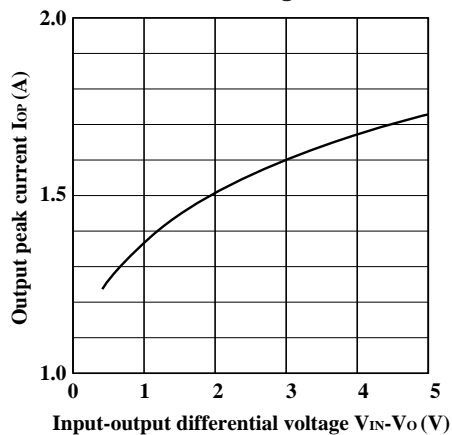
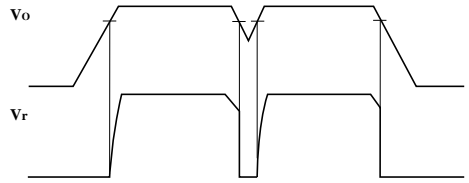
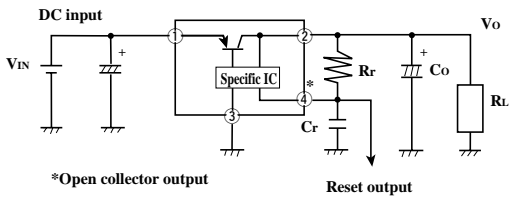

Fig.12 Output Peak Current vs. Input-output differential voltage



■ Typical Application

■ Reset Output Response Characteristics



### NOTICE

- The circuit application examples in this publication are provided to explain representative applications of SHARP devices and are not intended to guarantee any circuit design or license any intellectual property rights. SHARP takes no responsibility for any problems related to any intellectual property right of a third party resulting from the use of SHARP's devices.
- Contact SHARP in order to obtain the latest device specification sheets before using any SHARP device. SHARP reserves the right to make changes in the specifications, characteristics, data, materials, structure, and other contents described herein at any time without notice in order to improve design or reliability. Manufacturing locations are also subject to change without notice.
- Observe the following points when using any devices in this publication. SHARP takes no responsibility for damage caused by improper use of the devices which does not meet the conditions and absolute maximum ratings to be used specified in the relevant specification sheet nor meet the following conditions:
  - (i) The devices in this publication are designed for use in general electronic equipment designs such as:
    - Personal computers
    - Office automation equipment
    - Telecommunication equipment [terminal]
    - Test and measurement equipment
    - Industrial control
    - Audio visual equipment
    - Consumer electronics
  - (ii) Measures such as fail-safe function and redundant design should be taken to ensure reliability and safety when SHARP devices are used for or in connection with equipment that requires higher reliability such as:
    - Transportation control and safety equipment (i.e., aircraft, trains, automobiles, etc.)
    - Traffic signals
    - Gas leakage sensor breakers
    - Alarm equipment
    - Various safety devices, etc.
  - (iii) SHARP devices shall not be used for or in connection with equipment that requires an extremely high level of reliability and safety such as:
    - Space applications
    - Telecommunication equipment [trunk lines]
    - Nuclear power control equipment
    - Medical and other life support equipment (e.g., scuba).
- Contact a SHARP representative in advance when intending to use SHARP devices for any "specific" applications other than those recommended by SHARP or when it is unclear which category mentioned above controls the intended use.
- If the SHARP devices listed in this publication fall within the scope of strategic products described in the Foreign Exchange and Foreign Trade Control Law of Japan, it is necessary to obtain approval to export such SHARP devices.
- This publication is the proprietary product of SHARP and is copyrighted, with all rights reserved. Under the copyright laws, no part of this publication may be reproduced or transmitted in any form or by any means, electronic or mechanical, for any purpose, in whole or in part, without the express written permission of SHARP. Express written permission is also required before any use of this publication may be made by a third party.
- Contact and consult with a SHARP representative if there are any questions about the contents of this publication.